

vuje

EVERYTHING
UNDER ONE ROOF

2023



Nuclear Power Industry



STUDY

Pre-design analyses, feasibility studies



DESIGN

Construction proceeding, safety documentation and regulations, project management



CONSTRUCTION

Design, delivery, assembly, initialization, physical & power start-up, assessment of the equipment



OPERATION

Operation safety & reliability, personnel training, diagnostics, NDT inspections, development of manipulators



DECOMMISSIONING

NPP decommissioning
RAW management,
On-site works



High Voltage Grid



STUDY

Pre-design analyses,
feasibility studies

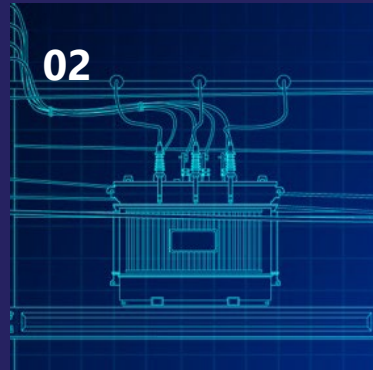

DESIGN

Construction
proceeding, design
elaboration, project
management



CONSTRUCTION

Management of
implementation
services, evaluation of
transmission & load
efficiency



OPERATION

Personnel training,
diagnostics, operation
of power stations

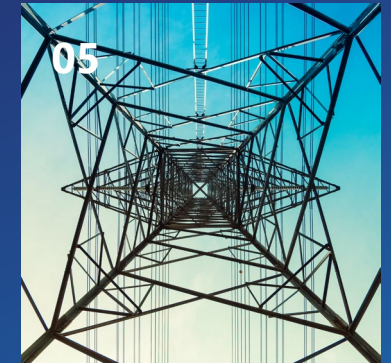

UPGRADE

Modernization
of distribution plants,
replacement of power
lines

Organization Structure

Shared Services

- Financial & Treasury
- Strategic Development and International Operations
- Procurement & Contracting
- Information Technologies
- Source and Asset Management

0200 Nuclear Safety Research and Development

0300 Diagnostic of Nuclear Power Components

0500 Engineering Services and Implementation

0600 NPPs Personnel Training Centre

0700 Radiation Safety, Decommissioning and Radioactive Waste Management

1200 Electric Grid Control and Operation Support

1700 New Build NPPs Preparation and Construction



0200 Nuclear Safety and R&D

- Comprehensive safety assessments of nuclear installations,
- Safety enhancement of nuclear units,
- Deterministic and probabilistic analyses of Nuclear Power Plants,
- Development of Emergency Planning and Preparedness,
- Commissioning of Nuclear Power Plants,
- Development of safety regulation and guideline for operators of nuclear installations,
- Research and development of generation IV. Gas-cooled Fast Reactor demonstrator ALLEGRO.

Some Significant Projects of VUJE with Participation of the Regulatory Body in Different Ways or Stage



- ✓ Siting of new NPP
- ✓ Completion of NPP Mochovce, Unit 3, 4
- ✓ Commissioning of the 3rd unit of NPP Mochovce MO34



<p>ÚRAD JADROVÉHO DOZORU SLOVENSKEJ REPUBLIKY</p> <p>EDÍCIA Bezpečnosť jadrových zariadení</p> <p>2022</p> <p>BN 5/2022 Rozsah a obsah bezpečnostnej správy (3. vydanie – revidované a doplnené)</p>	<p>ÚRAD JADROVÉHO DOZORU SLOVENSKEJ REPUBLIKY</p> <p>EDÍCIA Bezpečnosť jadrových zariadení</p> <p>2019</p> <p>BN 5/2019 Prílohy k deterministickým analýzám bezpečnosti JZ a VYLR-440/V212 (6. vydanie – revidované a doplnené)</p>	<p>ÚRAD JADROVÉHO DOZORU SLOVENSKEJ REPUBLIKY</p> <p>EDÍCIA Bezpečnosť jadrových zariadení</p> <p>2017</p> <p>BNS 1.9.3/2017 Prílohy k obsahu a rozsahu dokumentácie pre vyraňovanie, ktorá je predkladaná ako súčasť žiadosti v konaní o udelenie súhlasu podľa § 5 ods. 2 atómového zákona a v konaní o udelenie povolenia podľa § 5 ods. 3 písm. a) atď. atómového zákona</p>	<p>ÚRAD JADROVÉHO DOZORU SLOVENSKEJ REPUBLIKY</p> <p>EDÍCIA Bezpečnosť jadrových zariadení</p> <p>2016</p> <p>BNS H.9.2/2016 Hodnotenie mechanických charakteristík materiálov pre udržiavanie vybraných strojných zariadení pomocou metódy SPT</p>
---	--	---	--

Completion of NPP Mochovce, Unit 3, 4

- Design, delivery, installation, functional tests and commissioning of systems
- Qualification of components and equipment to inside containment and outside containment environmental conditions (LOCA conditions, seismic bed tests, thermal and radiation ageing, wear ageing, EMC)
- Documentation for Nuclear authority (classified equipment quality plans, qualification documents, support for manufacturing and installation documentation)
- Procurement management, delivery of individual equipment

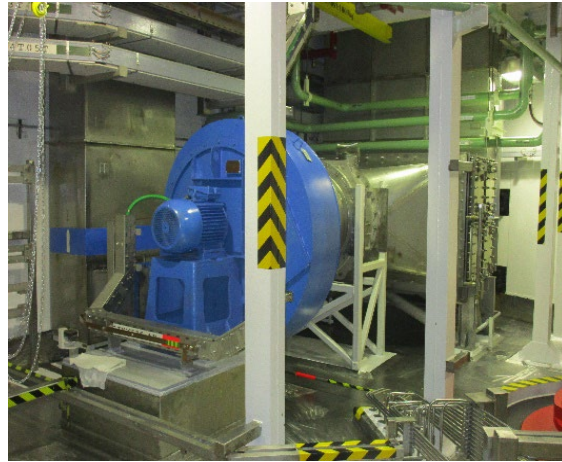

Brief List of Done Steps for Building New Power Plant up to now - Siting

Site selection

identification by screening, comparing based on established safety and suitability criteria (the best candidate was selected locality with existing nuclear facilities)

Management Summary and Feasibility Study

detailed financial and time analysis, inspection of technical solutions of realization, selection of applicable technologies of NPP
finished in 2012

Environmental Impact Assessment

Detailed environmental study of impacted areas
finished in 2015

Documentation defined by Atomic law for Regulatory Body to Gain permission to Facility Site

Initial Safety Analysis Report –the chapter „Site Characteristics“ was elaborated in as the greatest details as possible. The others should be prepared in reasonable rate. Technology is not defined – envelope approach was chosen to make possible transparent tender
finished in beginning of 2023

Siting of New NPP

All required documents had been completed
for obtaining a Permission from UJD SR to site new nuclear facility

- Initial Safety Analysis Report (considering IAEA SSG-61)
- Initial Report about Decommissioning Plan (considering IAEA SRS No. 77)
- Initial Report about Treatment with Radioactive Waste and Spent Nuclear Fuel
- Project Intention for Physical and Technical Solution of Nuclear Installation
– Design Development Project Level
- Requirements on the Quality of the Nuclear Installation
- Proposed Boundaries of the Nuclear Installation
- Proposed Size of the Emergency Planning Zone
- Environmental Impact Assessment of the Nuclear Installation
as well as Potential Impact Assessment of the Environment on the Nuclear Installation

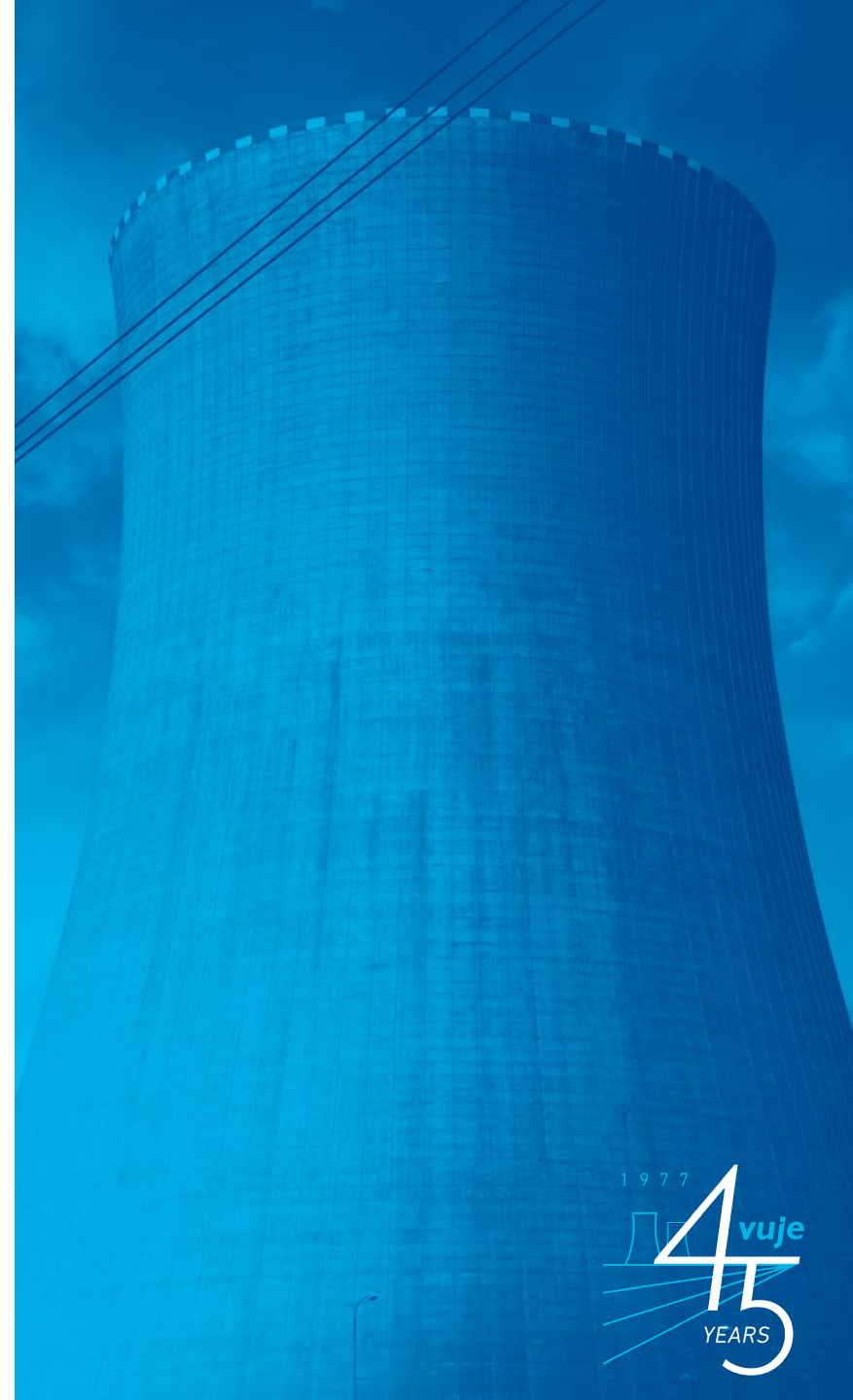

Siting of New NPP



Siting of New NPP

IAEA Safety Standards



Example of Licensing Process

- depends on regional nuclear regulatory authority requirements

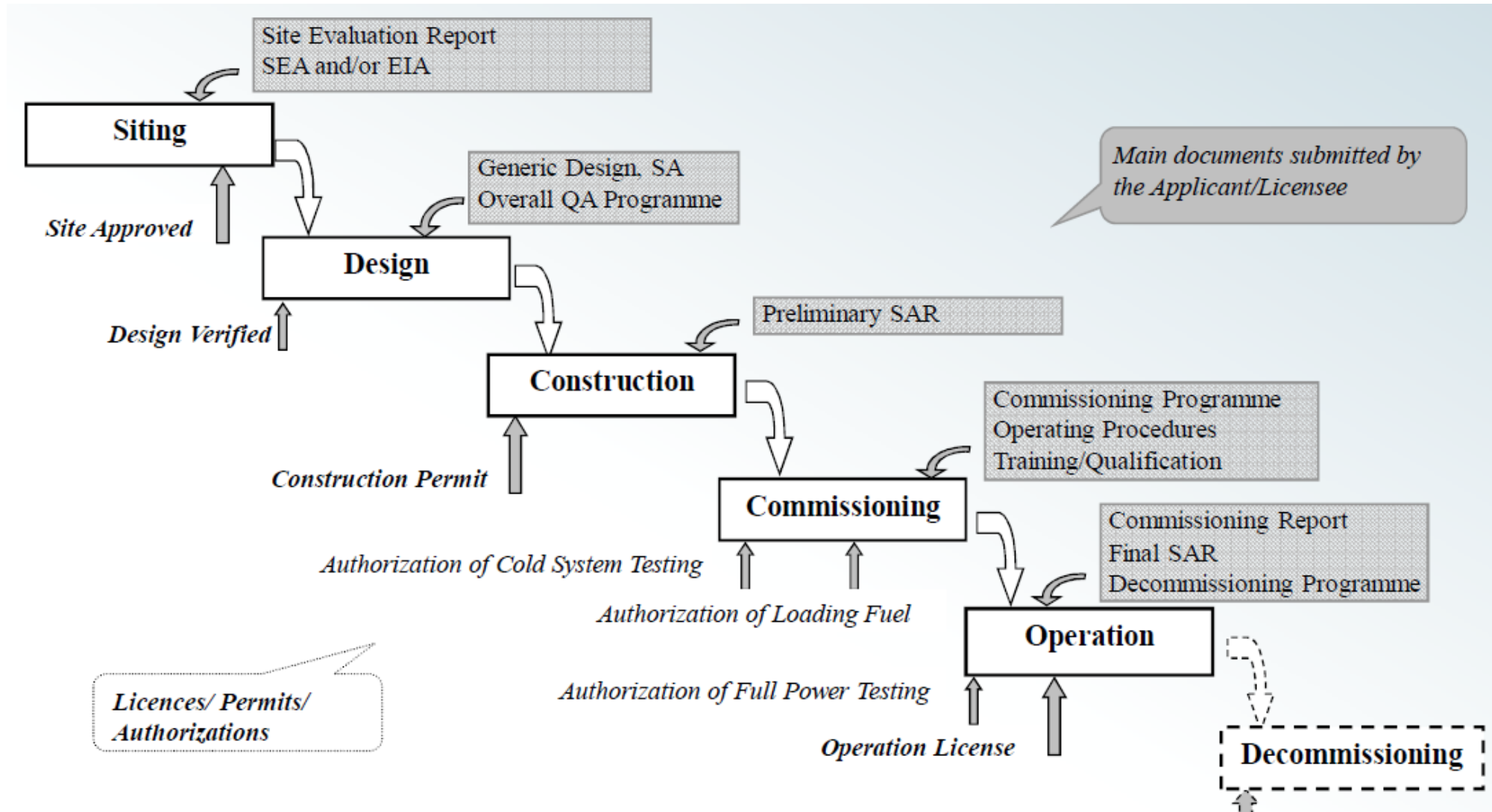

NPP Commissioning

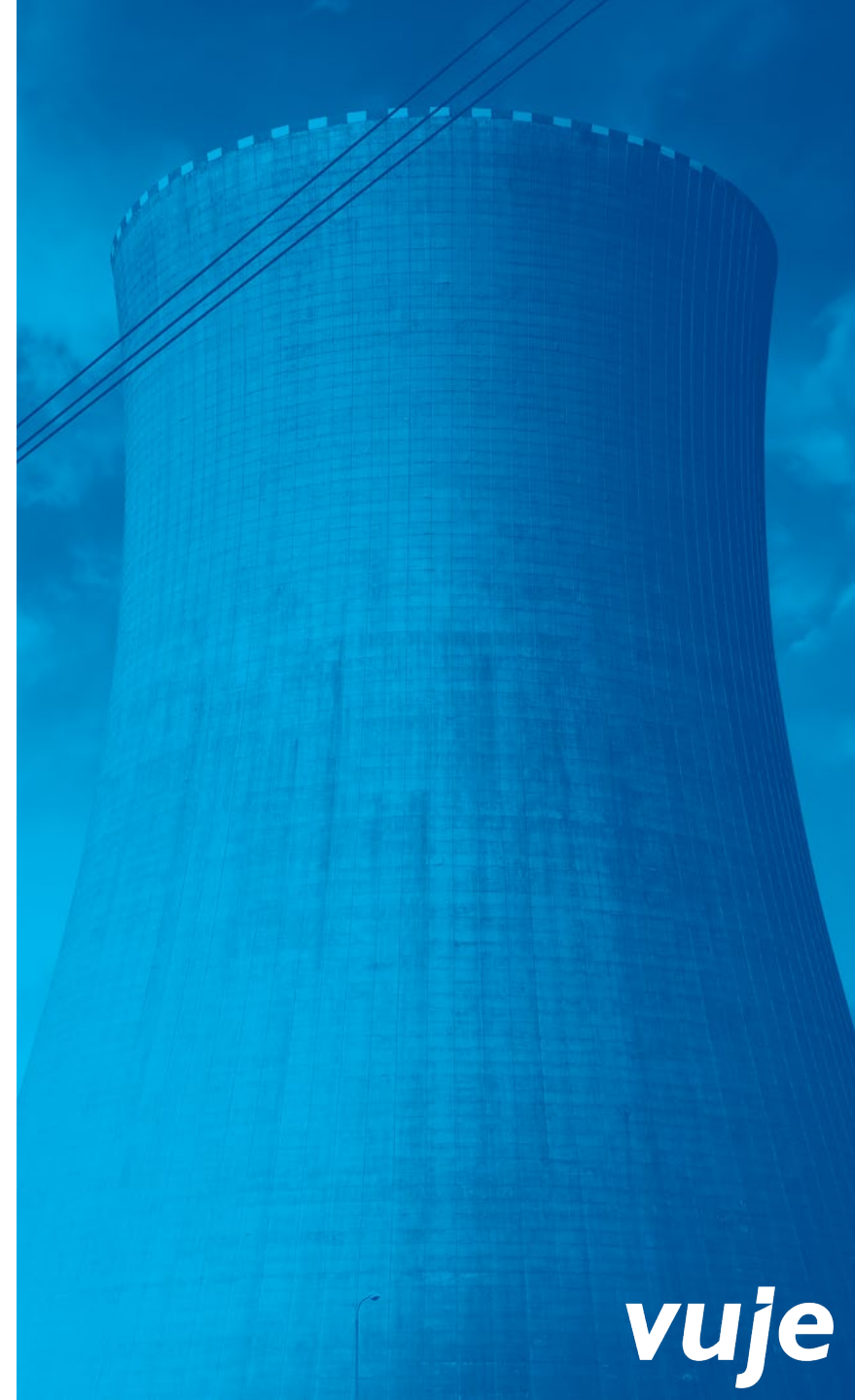

vuje

NPP Commissioning

- **Preparation of commissioning documentation**

Creation of commissioning group

Planning the commissioning programmes well in advance

Creation of test procedures

Theoretical data preparation (neutron-physical, thermal, hydraulic, technological, etc.)

Determination of the commissioning tests success criteria

Development and implementation of non-standard measurement systems for the required signals sensing

Development and verification of control and evaluation programmes

- **Performance of inactive and active commissioning tests**

Physics commissioning tests (reactor power $\leq 2\%$ N_{nom})

Power commissioning test (reactor power $> 2\%$ N_{nom})

- **Evaluation of the individual commissioning tests**

Preliminary evaluation – up to 24 hours after test completion

Final evaluation – up to 2 months after commissioning completion

- **Scientific leaders of commissioning**

The scientific commissioning leaders provide independent support to the operator in ensuring nuclear safety in the process of preparation and implementation of a nuclear power plant unit commissioning.

- **Technical support and consultancy**



Performance of commissioning tests

- Physics commissioning tests (reactor power $\leq 2\%$ Nnom)
- Power commissioning test (reactor power $> 2\%$ Nnom)

Evaluation of commissioning tests

- Preliminary evaluation – up to 24 hours after test completion
- Final evaluation – up to 2 months after commissioning completion

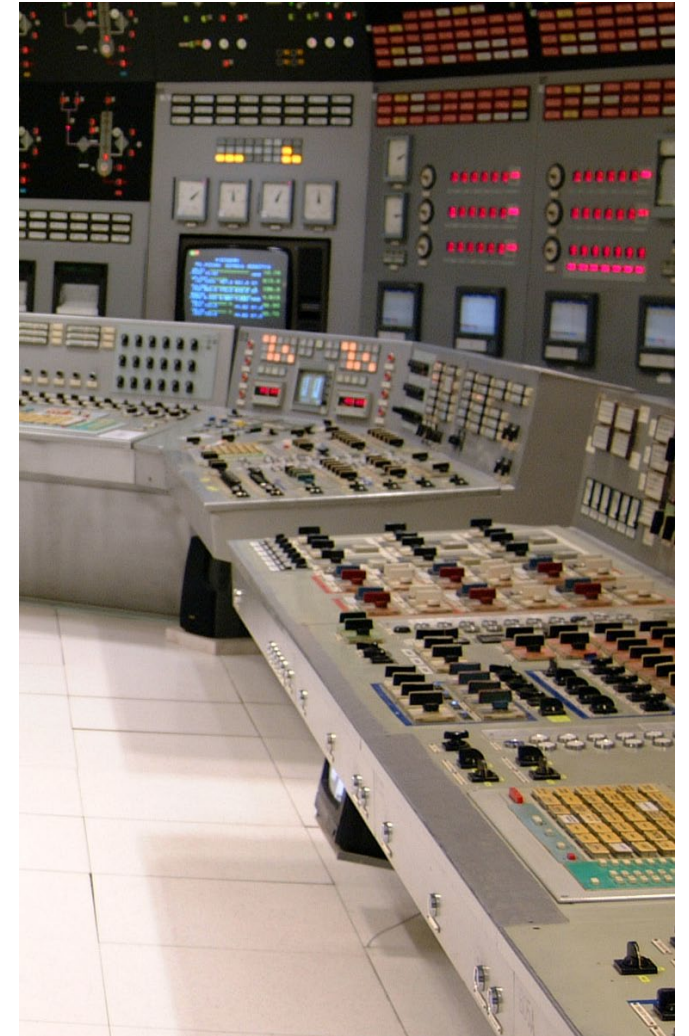

Physics commissioning tests

- Reactor core loading
- Reaching the reactor first criticality
- Control rod – Motor coupling test
- Determination of maximal reactor power for physics commissioning tests
- Reactivity computer checkout
- Reactor core load symmetry checkout
- Control rods efficiency measurement
- Measurement of thermal, pressure and power coefficient of reactivity
- Measurement of boric acid critical concentrations
- Determination of thermocouples data corrections during isothermal condition
- Boric acid efficiency measurement
- Measurement of "ejected" control rod efficiency
- Measurement of the primary circuit thermal loss and thermal capacity
- Neutron flux measurement system calibration
- Radiation situation monitoring
- Noise characteristics measurement

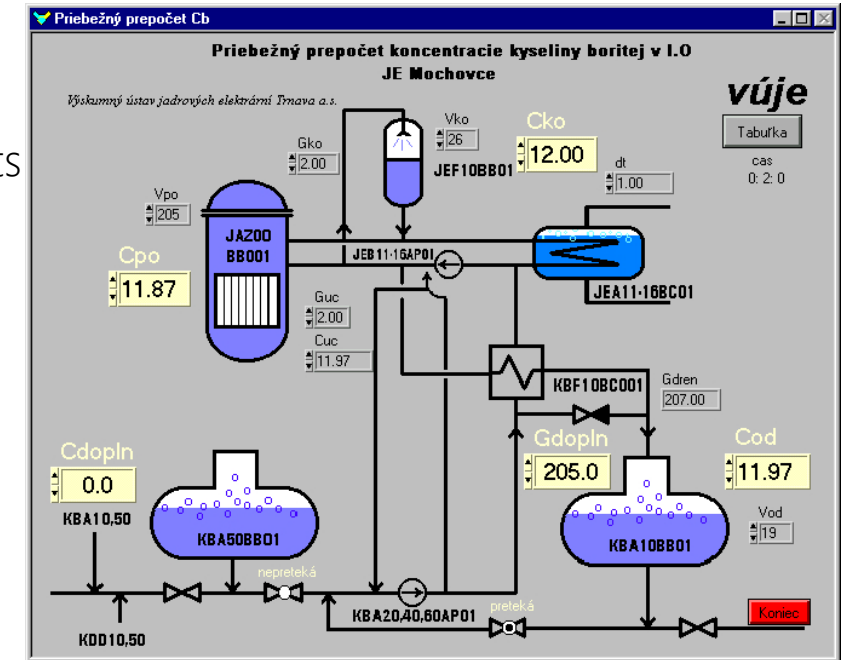

Power commissioning tests

The task of the power commissioning is to demonstrate the capability of NPP to work safely and in compliance with the design in normal conditions and after anticipated operation events.

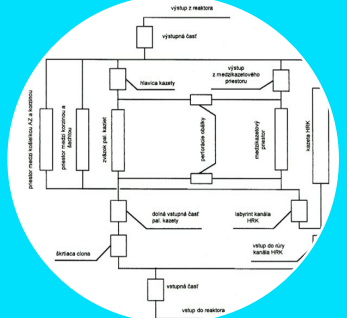

thermo-hydraulic tests

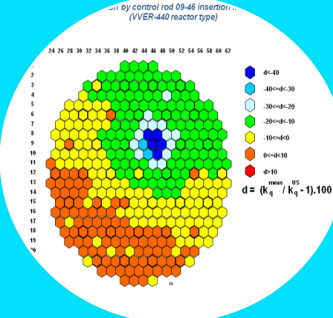

physics tests

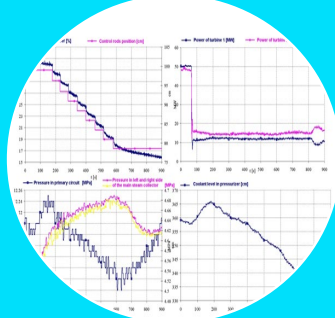

dynamic tests

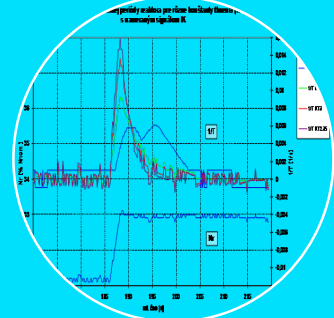

inspection and calibration measurements



Scientific commissioning leaders

The scientific commissioning leaders provide independent support to the operator in ensuring nuclear safety in the process of preparation and implementation of a nuclear power plant unit commissioning.

- professional and expert works focused on the method and inspection of compliance with nuclear safety
- assessment of selected operational, safety and commissioning documentation
- inspection of the NPP unit equipment and documentation readiness for the individual commissioning stages.

- independent unit inspection, assessment of the course and evaluation of the functional capability tests of equipment and systems related to nuclear safety in the stage of inactive tests.

- continuous inspection of the course of commissioning and tests results during physics and power commissioning by shift scientific leaders of commissioning
- recommendations for moving to the next stage of commissioning
- summary evaluation of the commissioning including recommendations for operation of the commissioned NPP unit

References



Units commissioning:

- Bohunice NPP (4 units of VVER-440 type), from 1978 to 1985
- Dukovany NPP (4 units of VVER-440 type), from 1985 to 1987
- Mochovce NPP, Units 1&2 (2 units of VVER-440 type), from 1998 to 2000
- Temelín NPP (2 units of VVER-1000 type), from 2000 to 2002
- Mochovce NPP, Units 3&4 (Unit 3, 2022-2023)
- Bohunice NPP, Units 3&4 after modernisation from 2007 to 2008
- Mochovce NPP, Units 1&2 during power uprate of units in 2008
- Bohunice NPP, Units 3&4 during power uprate of units from 2008 to 2010

References

	Name	Reactor Type	Put in to Operation	Note
1	NPP Bohunice A1	KS-150	December, 1972	Shutdown May 1979
2	NPP Bohunice V1 Unit 1	VVER440/230	December, 1978	Shutdown December 2006
3	NPP Bohunice V1 Unit2	VVER440/230	March, 1980	Shutdown December 2008
4	NPP Bohunice V2 Unit3	VVER440/213	August, 1984	Modernization + Power Up-rate 107% Electric output 500 MW
5	NPP Bohunice V2 Unit4	VVER440/213	August, 1985	Modernization + Power Up-rate 107% Electric output 500 MW
6	NPP Mochovce Unit 1	VVER440/213	Jul 1998	Power Up-rate 107% Electric output 500 MW
7	NPP Mochovce Unit 2	VVER440/213	December, 1999	Power Up-rate 107% Electric output 500 MW
8	NPP Mochovce Unit 3	VVER440/213	Commissioning	Project Finalization + licensing
9	NPP Mochovce Unit 4	VVER440/213	Under Construction	Project Finalization + licensing

vuje

Contacts:

VUJE, a. s.

Okružná 5
918 64 Trnava
Slovak Republic

Phone: + 421 33 599 1111
Fax: + 421 33 599 1200
E-mail: vuje@vuje.sk
Web: www.vuje.sk

